

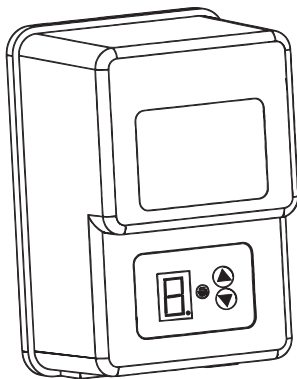

READ AND SAVE THESE INSTRUCTIONS



Low Voltage  
**120W GARDEN LIGHT  
TRANSFORMER**

**DEAR CUSTOMER,**

Congratulations on your purchase of KhanTech lighting product. Our products will help to enhance the beauty of your home and provide many years of enjoyment. Khan offers a wide selection of lighting products of the highest professional quality. Ask your dealer about the many other Khan products that will help to create your own brand.

To ensure the maximum performance of your garden light, please read and save these instructions.

Replacement parts may be ordered by using the fixture model number and the part's name.

**IMPORTANT SAFETY INFORMATION PERTAINING TO RISK OF FIRE OR INJURY TO PERSONS.**

- Do not install within 10 feet (3 m) of a pool, spa or fountain.
- For use with 12 volt low voltage outdoor landscape lighting system only.
- Not for use with submersible lights or pool/spa equipment.
- There are no serviceable parts inside the power supply unit.

**DO NOT DISASSEMBLE.**

- Do not submerge transformer.
- Do not connect two or more transformers in parallel.
- Do not use with a dimmer.
- Plug the power supply unit directly into a GFCI outlet that is marked "wet location".
- Do not use an extension cord.
- The maximum output of this transformer is 120 watts. Do not overload the transformer. Be sure that the total cumulative wattage of all 12 volt fixtures connected to the transformer is equal to or less than 120 watts per secondary terminal.

**PLEASE NOTE:** This garden light system must be installed in accordance with all local codes and ordinances. If you are experiencing problems, contact a qualified electrician.

FOR LANDSCAPE LIGHTING SYSTEMS ONLY. OUTDOOR USE ONLY.

THE DEVICE IS ACCEPTED AS A COMPONENT OF A LANDSCAPE LIGHTING SYSTEM WHERE THE SUITABILITY OF THE COMBINATION SHALL BE DETERMINED BY CSA OR LOCAL INSPECTION AUTHORITIES HAVING JURISDICTION.

CUSTOMER SERVICE

Phone: 267-495-5532 Email: info@khantech-co.com Address: PO Box 130, Abington PA 19001

## 1. Find a location for the transformer

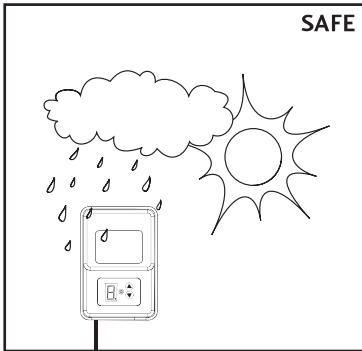

1.1 Outdoor use, weather proof.

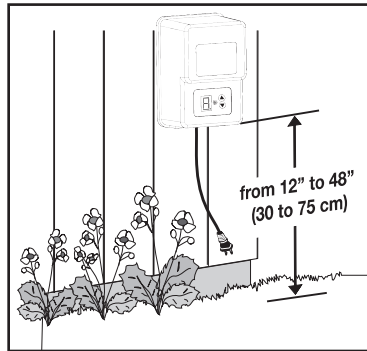

1.2 Install the transformer at a level where the controls are visible and accessible.

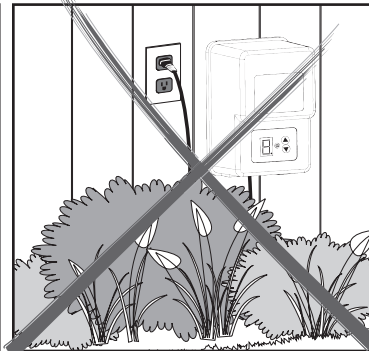

1.3 Do not install behind shrubs. It will affect photocell.

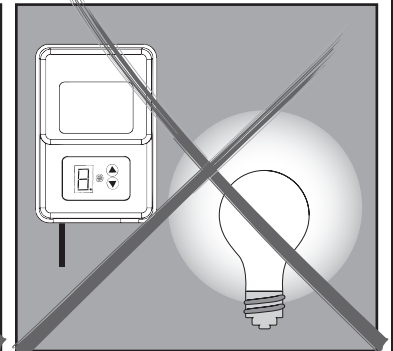

1.4 Photocell will not operate properly if installed too close to a nighttime light source.

## 2. Connect cable to transformer

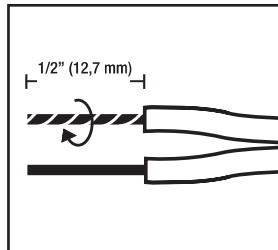
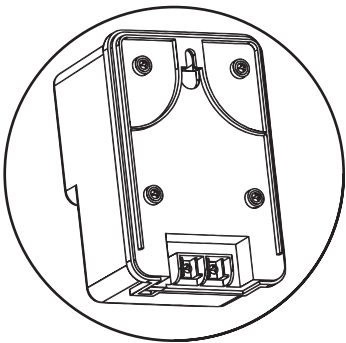

3.1 Remove the landscape wire insulation 1/2" from both wires and twist ends.

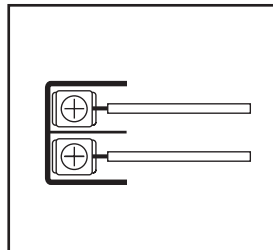

3.2 Insert wires under each terminal plate and tighten screws.

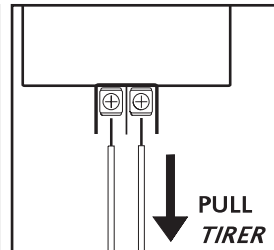

3.3 Gently pull on the landscape wire to verify if the connection is strong.

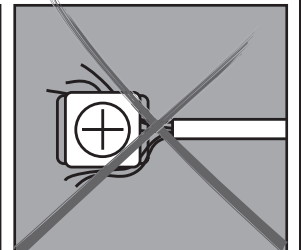

3.4 Verify that there are no loose cable strands. **⚠WARNING!** Must be evenly and tightly fixed to avoid getting melted connecting

## 3. Mount the transformer

Insert a screw in a wall near an electrical outlet and mount the transformer.

**Note:** Use an outdoor, weather resistant screw suitable to the material that you are mounting the transformer onto (mortar screws into cement or brick, wood screws for wood siding). The size of the screw should be at least SAE #4 (Metric M3) to support the weight of the transformer.

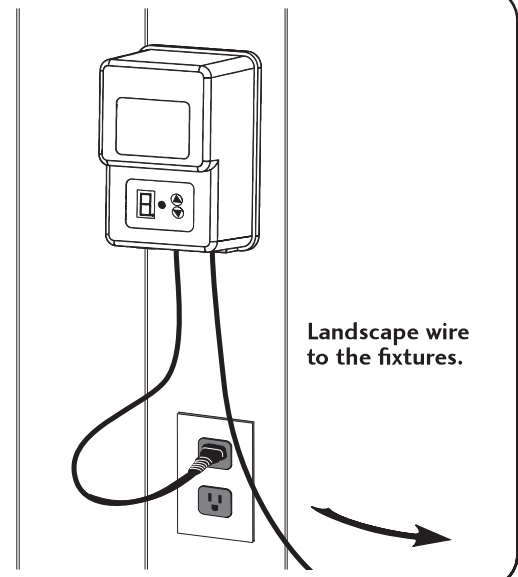
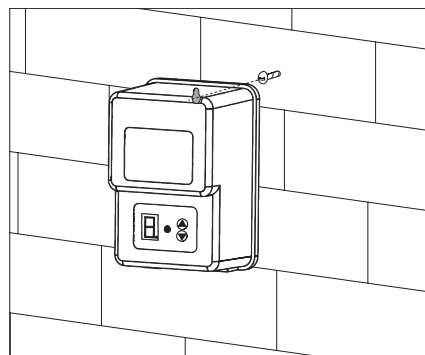

## 4. Run the Landscape Wire (Not Included)

The landscape wire should run from the transformer to each light without being cut. Do not run the landscape wire within 10 feet (3m) of a pool, spa or fountain. If the landscape wire is too long, cut it with a cable cutter.

The landscape wire should be protected by routing it close to proximity of the light fixture or next to a building, deck or fence. Use cable suitable for low voltage landscape lighting.

See chart below for recommended cable gauges.

*\*Suitable cable should be sized in accordance to the table, should be Type SPT-2W.*

Combined wattage of all fixtures on line (in Watts)	Wire Gage (0-75')	Wire Gage (75'-150')	Wire Gage (150'-250')
0-60	16	16	14
60-120	16	14	12
120-180	14	12	12
180-240	12	12	Not recommended
240-300	12	Not recommended	Not recommended

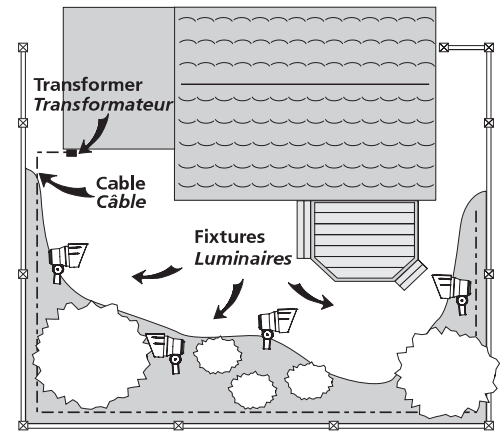

\* Illustration of fixtures is for example only.

## 5. Power up the transformer

- Plug the transformer into a GFCI electrical receptacle.
- To test the fixtures, cover the photocell with black tape and turn the control switch to the ON position.
- After the installation is complete, remove the tape.

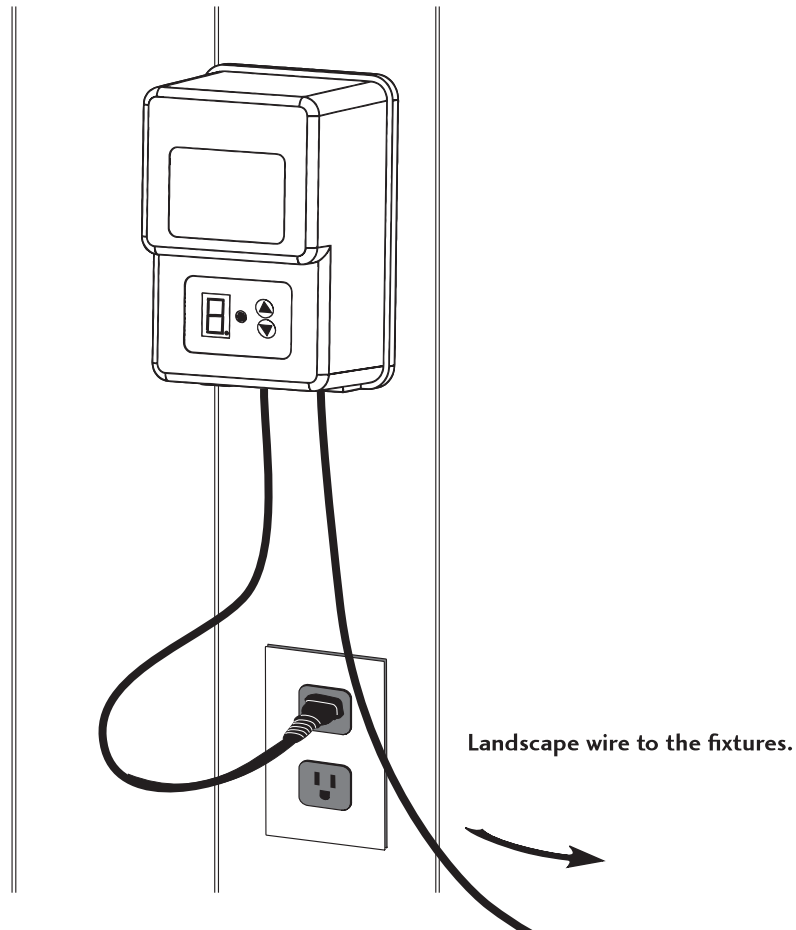

## 6. How to operate the transformer controls

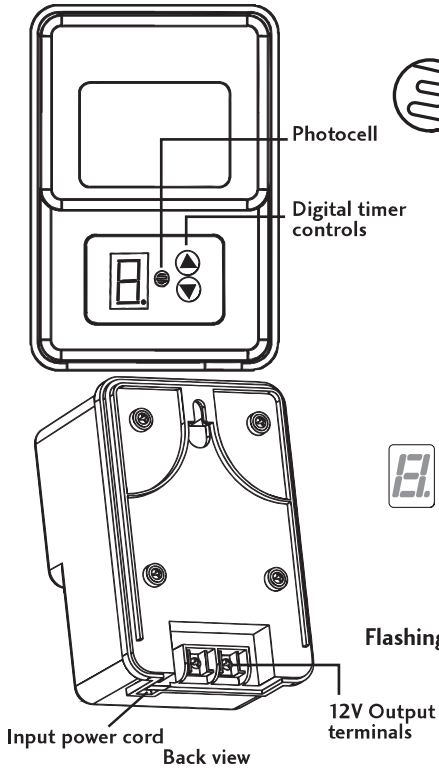

### Photocell

This component reacts to light conditions. It should not have direct contact with any other light sources. A 30 second delay may be experienced when light conditions change.

To test the system during day time, simply cover the photocell with black tape.



### Digital Timer Controls

Use the UP ▲ and DOWN ▼ control buttons to select from the following settings:



• **Power:** Whenever the  is present, there is power on the low voltage side of the transformer.



**Constant power ON:** This switches the system on 24 hours a day.



**AUTO:** This switches the system on at dusk and off at dawn, automatically.



**AUTO TIMER:** This switches the system on at dusk and off after the selected number of hours.

Flashing 



**Minor Overload:** The load on the transformer exceeds it's capacity. Reduce the load by removing fixtures from the low voltage line. Failure to do so will reduce the lifetime of the transformer.

### Display off - Major Overload or short circuit

If the display is off and that the utility voltage is still present the transformer is majorly overloaded. The major overload feature will shut off the low voltage output of the power unit, if the circuit is overloaded with too many fixtures. This will result when the total wattage of all lights of the system exceeds 100 Watts. The major overload shut off will also happen if there is a short circuit in your garden lighting system. A short circuit can occur if the secondary cable connecting the fixtures to the power supply is cut or if the exposed ends touch a metal post or water. After you have determined and solved the problem, you can restart the operation by pressing the ▲ button. If the display is off and that the utility voltage is still present the transformer is majorly overloaded.

## 7. Troubleshooting

All of the lights fail to work

- Check that the transformer power is on.
- Check if there is a loose connection at the transformer screw terminal.
- Check that the power switch is not in the OFF setting.

Only some lights work

- The problem here is with the fixture's connector or light bulb.
- Check the connector to make sure the wire stabs have pierced the landscape wire and the fixture wire.
- To check a light bulb, exchange it with one from a fixture that is working (remember to be careful, as the bulbs can get very hot – also touch bulbs with a soft cloth only).

The lights are "ON" during the day

- The power unit is in a dark area which triggers the photocell to turn ON the lights.

The lights do not switch "ON" at dusk

- The power unit is in a area where there is too much light at night.

## 8. Maintenance

- To clean, wash with a damp soft cloth.